



G4WPW

Microphone Connections

For The Radio Amateur



'In compliance with the 'true spirit of amateur radio' this website information is available without restrictions to all Radio Amateurs' and radio communication enthusiasts worldwide.

IF YOU HAVE ANY MICROPHONE INFORMATION YOU WOULD LIKE TO ADD TO
 HELP OTHER RADIO AMATEURS-PLEASE E-MAIL ME. rg4wpw@ntlworld.com
 MY SINCERE THANKS GO TO THE RADIO AMATEURS WORLDWIDE WHO HAVE
 CONTRIBUTED WITH THEIR FEEDBACK, INFORMATION AND CORRECTION'S.

[PORTUGUESE TRANSLATION.](#)

My sincere thanks to my friend Ubiracy PUILHP for the above translation.



UK SITE .



USA SITE .

PLEASE NOTE !

During the past eleven years many hours have been spent drawing diagrams producing photographs, compiling these lists and cross checking this information for error's. I accept no responsibility for any error's or problems that may result from using this information
 I would appreciate your feedback if any error's or omissions are noted in the diagrams or listing.
 I accept no responsibility for information that is copied from this website and reproduced in any format on other websites.
 Some information is copyright and remains the property of the respective equipment manufacturer or diagram designer/photographer.
 If you wish to use any of this information on your website please contact me I will be delighted to assist you.

[DOWNLOADING INFO](#)

73 de



POPULAR MICROPHONE PLUG AND SOCKET PINOUTS.

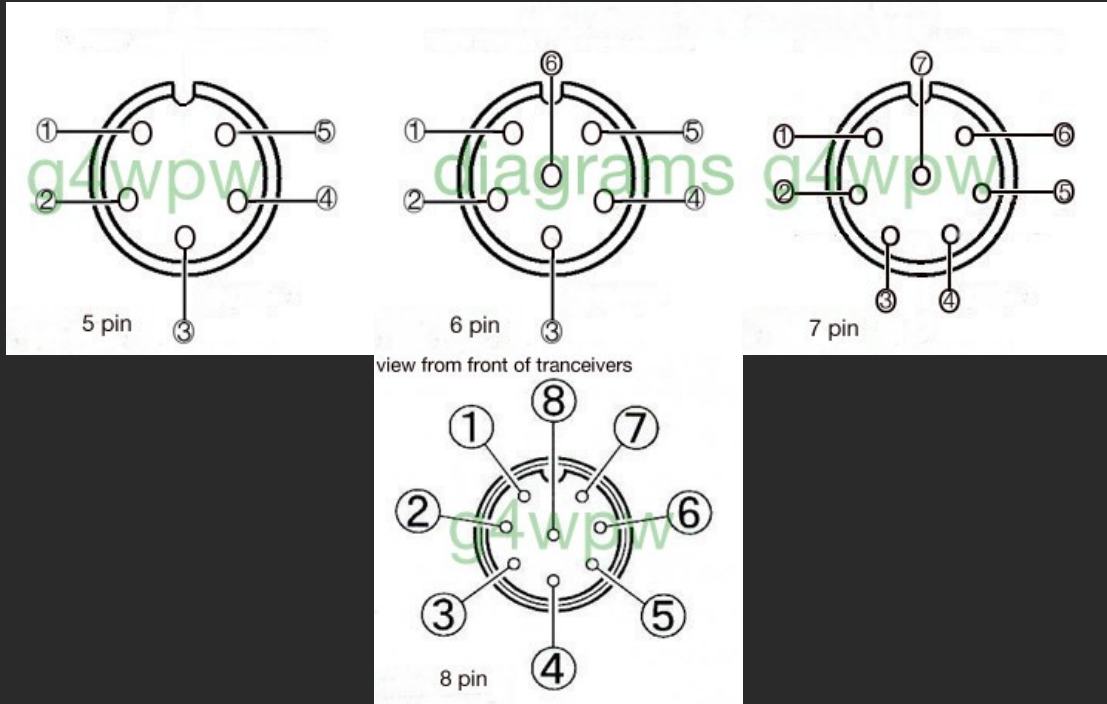

diagrams g4wpw

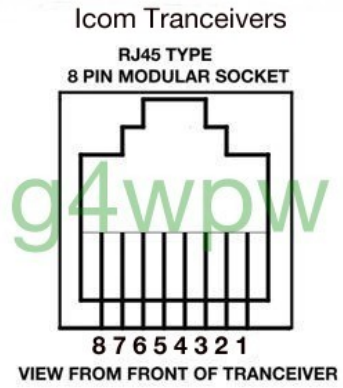
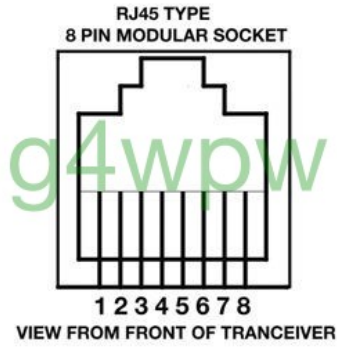
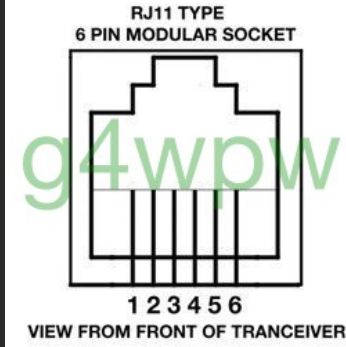

X=(cannon x) L=(Latch) R=(rubber compound)

SKIP TO

KENWOOD

YAESU

ICOM

ALINCO

ADONIS

**OTHER MIC CONNECTIONS
A-Z**

TRIO/KENWOOD.

Kenwood Most popular connections

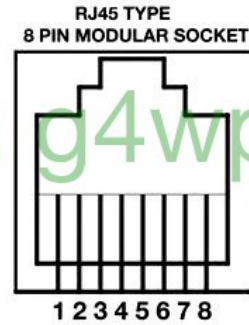
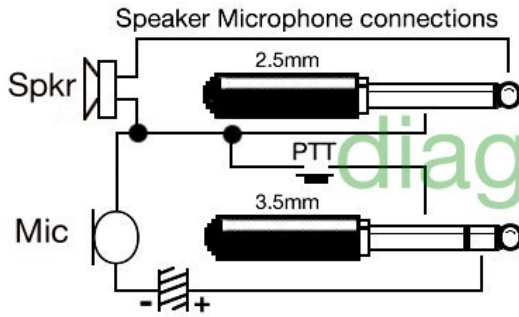

- Pin 1 Up
- Pin 2 8v DC
- Pin 3 Ground
- Pin 4 PTT
- Pin 5 Ground
- Pin 6 Mic
- Pin 7 RX audio some models
- Pin 8 Down

VIEW FROM FRONT OF TRANCEIVER

VIEW FROM FRONT OF TRANCEIVER

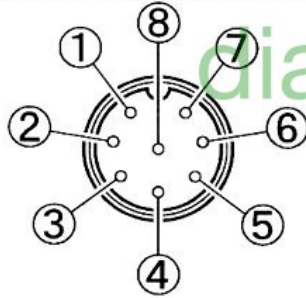

- Pin 1 Mic
- Pin 2 PTT
- Pin 3 Down
- Pin 4 Up
- Pin 5 8v DC
- Pin 6 RX audio some models
- Pin 7 Mic ground
- Pin 8 Ground

Data Connection

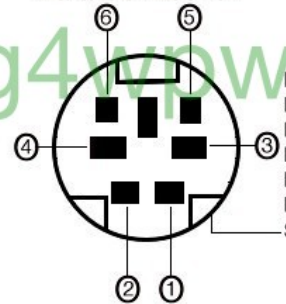

- Pin 1 Data in (Mic)
- Pin 2 Ground (Mic Gnd)
- Pin 3 Packet standby (PTT)
- Pin 4 9600 bps RX audio o/p
- Pin 5 1200 bps RX audio o/p
- Pin 6 Squelch control o/p
- Shell Earth (Ground)

KENWOOD MICROPHONES.

KENWOOD- MC-10 MICROPHONE.

KENWOOD- MC-30 / 35 MICROPHONE.

KENWOOD- MC-42S MICROPHONE.

KENWOOD- MC-43 MICROPHONE.

KENWOOD- MC-44 MICROPHONE.

KENWOOD- MC-45 MICROPHONE (mk1).

KENWOOD- MC-45 MICROPHONE (mk2).

KENWOOD- MC-46 MICROPHONE.

KENWOOD- MC-47 MICROPHONE.

KENWOOD- MC-48B MICROPHONE.

KENWOOD- MC-50 MICROPHONE. pdf.

KENWOOD- MC-52DM MICROPHONE.

KENWOOD- MC-53DM MICROPHONE.

KENWOOD- MC-55 MICROPHONE.

KENWOOD- MC-57 MICROPHONE.

KENWOOD- MC-58 MICROPHONE.

KENWOOD- MC-59 MICROPHONE.

KENWOOD- MC-60 MICROPHONE.

KENWOOD- MC-60A MICROPHONE.

KENWOOD- MC-80 MICROPHONE.

KENWOOD- MC-85 MICROPHONE.

KENWOOD- MC-85 SCHEMATIC pdf.

KENWOOD- MC-90 MICROPHONE.

KENWOOD- SMC-25 SMC-30 SPEAKER/MIC.

KENWOOD- SMC-32 SPEAKER/MIC.

KENWOOD- SMC-33 SPEAKER/MIC.

KENWOOD- SMC-32 SMC-33 SMC-34 SCHEMATIC pdf.

KENWOOD- KMC-9C KMC-30 KMC-32 KMC-35 KMC-36 MICROPHONES.

MJ-88 CONNECTING CABLE.

KENWOOD MICROPHONE COMPATIBILITY LIST pdf.

MORE KENWOOD CONNECTION INFO.pdf file**KENWOOD INSTRUCTION MANUAL & CONTROL SOFTWARE.**

KENWOOD(Handheld Tranceiver's)-TH-22A/AE TH-28/AE TH-42A/AE TH-48/AE TH-78A/E TH-F6 TH-F7 TH-F7E THG-71 TH-D7A/E TH-K2AT TH-K2E TH-K4E TH-K4AT TH-235 UBZ-LJ8BE UBZ-LJ8SLE UBZ-LJ8YE VBZ-LH14 VBZ-LF AR-14 GR-14
(see SMC-32 SMC-33 SMC-34 above for external microphone and PC interconnection)

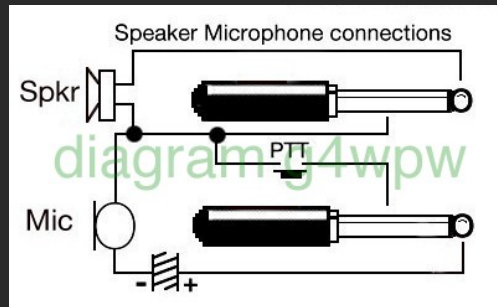
KENWOOD(Handheld Tranceiver's)-TR-2500 TR-2600

(see SMC-25/SMC-30 above.)

KENWOOD-T599S-TS120S-120V-700G-700S-130S-130V-490-520S-530S-820S-830S-TR2300-TR2200-TR2200GX-TR3200-TR7010-TR7200-TR7200G-TR7400A-TR7500-TR7600-TR7625

PIN1	MIC
PIN2	PTT
PIN3	PTT/EARTH
PIN4	SCREEN AND EARTH

**7 PIN REMOTE PLUG/SOCKET.**

KENWOOD-TS120-130-140-180-430-440-450-530-570-680-690-830-870-940-950.

PIN1	SPEAKER OUT
PIN2	RELAY COMMON GROUND/EARTH
PIN3	PTT FOR FOOT SWITCH
PIN4	RELAY CLOSED ON TRANSMIT
PIN5	RELAY OPEN ON TRANSMIT
PIN6	ALC INPUT
PIN7	+12VOLTS ON TRANSMIT (10 Ma Max)
PLUG	SHELL EARTH.

6 PIN ACC PLUG/SOCKET.

KENWOOD-TS-450-690-570-850-870-950.

PIN1	SIGNAL GROUND/EARTH
PIN2	TRANSMIT DATA
PIN3	RECEIVE DATA
PIN4	CTS ENABLE TX
PIN5	RTS ENABLE RX
PIN6	N/C
SHELL	EARTH

13 PIN ACC2 PLUG.**KENWOOD-TS440-450-680-690-570-711-790-811-850-870-940-950**

PIN1	N/C
PIN2	N/C
PIN3	RX AUDIO OUT
PIN4	SCREEN FOR PIN3
PIN5	SQUELCH CONTROL OR N/C
PIN6	S/METER OUTPUT
PIN7	N/C
PIN8	CHASSIS/GROUND
PIN9	PTT- STANDARD MIC INPUT IS MUTED
PIN10	N/C
PIN11	MIC INPUT
PIN12	SCREEN FOR PIN 11
PIN13	PTT- STANDARD MIC INPUT IS ACTIVE
SHELL	EARTH

KENWOOD-TR9000-9030-9130-9300-9500-7700-7730-7750-7800-7850-7930-7950-8400

PIN1	MIC
PIN2	PTT
PIN3	DOWN
PIN6/CENTER	EARTH
PIN4	UP
PIN5	NC + <u>8VOLT SOME MODELS</u>

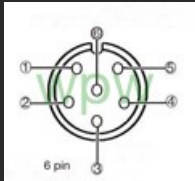
**KENWOOD-TR7600-TR7625**

PIN1	MIC
PIN2	PTT
PIN3	N/C
PIN4	CHASSIS/GROUND
PIN5	MIC SCREEN

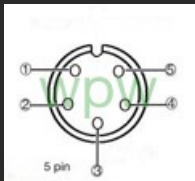
**KENWOOD-TS480 (8 Pin modular Plug)**

PIN1	UP
PIN2	+8 VOLTS
PIN3	GND
PIN4	PTT
PIN5	MIC GND
PIN6	MIC
PIN7	N/C
PIN8	DOWN

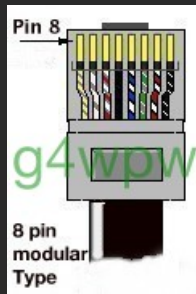

UPDATE.

Some errors in the TS-480 schematics leading to RF feedback when using other than the stock microphone have been noted by Kenwood.

MORE INFO TO FOLLOW.

KENWOOD-TS-50-60-140-430-440-450-570-660-670-780-930-430-670-711
TS-811-850-870-930-940-950-440-701-790-680-690-TS-2000
TR-3200-7900-7950-50-751-851
TM-201A-201B-401A-TM401B-211-221-231-241-321-331-3530-421-431-441-521-531-541
TM-621-631-701-721-731-2530-2550-2570
TW4000-4100

PIN1	MIC
PIN2	PTT
PIN3	DOWN
PIN4	UP
PIN5	+ 8VOLT Some models (10 Ma)
PIN6	(N/C Some models)
PIN7	MIC GROUND.
PIN8	GROUND (STBY)

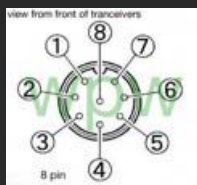

KENWOOD-TM-251-255-261-271-271E-451-455-461-641-642-708-732-733-741-742-941-942 (8 Pin modular Plug)
TMG-707 TMD-700 TMD700A TMV-71A.TMV-71E-V7A.

KENWOOD PMR TRANCEIVER MODELS-TK-90-7108HM-7108M-7160E-7160HM-7160M-7162E-7180E-7189E
8108HM-8108M-8160E-8160M-8162E-8180E-8189-TK90 (see KMC-30 /32 /35 above)

PIN1	UP
PIN2	+8 VOLTS (100ma max)
PIN3	GND
PIN4	PTT
PIN5	MIC GND
PIN6	MIC
PIN7	N/C. RX AUDIO (some models)
PIN8	DOWN

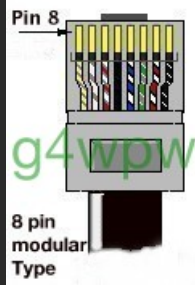

KENWOOD-TM-271A (8 Pin modular Plug)

PIN1	N/C
PIN2	+8 VOLTS (100ma max)
PIN3	GND
PIN4	PTT
PIN5	MIC GND
PIN6	MIC (600 ohm impedance)
PIN7	N/C
PIN8	KEYPAD SERIAL DATA.

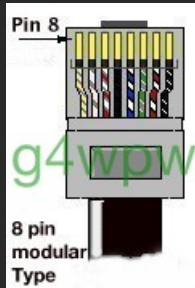

YAESU.

Further to a telephone call and query to 'YAESU UK' Technical Department today. 18th-APRIL-08.

PLEASE NOTE:

It is understood from Yaesu that in some cases an alternative cable source was used during the mic manufacturing process and that microphones of Identical type and model number MAY NOT always have the same color coded connecting cable.

YAESU MICROPHONES.

YAESU- YM-21. Microphone.
YAESU- YM-22. Microphone.
YAESU- YM-34. Microphone
YAESU- YM-35. Microphone
YAESU- YM-36. Microphone
YAESU- YM-37. Microphone
YAESU- YM-38. Microphone
YAESU- YM-40. Microphone
YAESU- YM-47. Microphone.
YEASU- YM-48. Microphone.
YAESU- YM-49. Microphone.
YEASU- YM-50. Microphone.
YEASU- YM-86. Microphone.
YAESU- YM-846. Microphone.

[YAESU- YM-2500. Microphone.](#)
[YAESU- YD-148. Microphone.](#)
[YAESU- YD-844. Microphone.](#)
[YAESU- YE-7A. Microphone.](#)
[YAESU- MD-1B8. Microphone.](#)
[YAESU- MD-1C8. Microphone.](#)
[YAESU- MH-1A3B. Microphone.](#)
[YAESU- MH-1B8. Microphone.](#)
[YAESU- MH-10E8 MH-10F8. Microphone.](#)
[YAESU- MH-12A2B. Microphone.](#)
[YAESU- MH-14A8. Microphone.](#)
[YAESU- MH-14B8. Microphone.](#)
[YAESU- MH-14D8. Microphone.](#)
[YAESU- MH-15C8. Microphone.](#)
[YAESU- MH-15D8. Microphone.](#)
[YAESU- MH-18A2B. Microphone.](#)
[YAESU- MH-19A2B. Microphone.](#)
[YAESU- MH-25A8J. Microphone.](#)
[YAESU- MH-26. Microphone.](#)
[YAESU- MH-26G8J. Microphone.](#)
[YAESU- MH-27. Microphone.](#)
[YAESU- MH-27A8J. Microphone.](#)
[YAESU- MH-29A2B. Microphone.](#)
[YAESU- MH-31. Microphone.](#)
[YAESU- MH-31B8. Microphone.](#)
[YAESU- MH-31A8J. Microphone.](#)
[YAESU- MH-32A2B. Microphone.](#)
[YAESU- MH-34 / MH-34B4. Microphone.](#)
[YAESU- MH-34C2B. Microphone.](#)
[YAESU- MH-36. Microphone.](#)
[YAESU- MH-36A6J DTMF Microphone.](#)
[YAESU- MH-36B6JS Microphone.](#)
[YAESU- MH-36D8 Microphone.](#)
[YAESU- MH-36E8J DTMF Microphone.](#)
[YAESU- MH-37A4B Microphone.](#)
[YAESU- MH-42. Microphone.](#)
[YAESU- MH-42A6J Microphone.](#)
[YAESU- MH-42B6JS Microphone.](#)
[YAESU- MH-42B6J Microphone schematic.pdf](#)
[YAESU- MH-44A4B Microphone.](#)
[YAESU- MH-48. Microphone.](#)
[YAESU- MH-48A6J. Microphone.](#)
[YAESU- MH-57A4B. Microphone.](#)
[YAESU- MH-59A8J. Microphone.](#)
[YAESU- MH-61A8J. Microphone.](#)
[YAESU- MH-64A8J. Microphone.](#)
[YAESU- MH-67A8J. Microphone.](#)
[YAESU- MH-68A8J. Microphone.](#)
[YAESU- MH-700D. Microphone.](#)
[YAESU- MD-11A8J. Microphone.](#)
[YAESU- MD-100. Microphone.](#)
[YAESU- MD-100A8X. Microphone.](#)
[YAESU- MD-100/100AX schematic.pdf](#)
[YAESU- MD-200. Microphone.](#)
[YAESU- MD-200A8X. Microphone.](#)
[YAESU- MD-200. Instruction Manual.pdf](#)

[YAESU MICROPHONE COMPATIBILITY LIST.](#)

[YAESU STANDARD MICROPHONE LIST.](#)

[MORE YAESU MICROPHONE INFO.](#)

[YAESU TNC INFORMATION.](#)

YAESU (Handheld Tranceiver's) [VX-1R](#) [VXF-1](#) [VX-2R](#) [VX-2E](#) [VX-3R](#) [VX-5R](#) [VX-7R](#) [VX-10](#) [VXF-10](#) [VX-110](#)
[VX-130](#) [VX-131](#) [VX-132](#) [VX-150](#) [VX-160](#) [VX-180](#) [VX-210](#) [VX-210A](#) [VX-300](#) [VX-400](#) [VX-410](#) [VX-420](#)

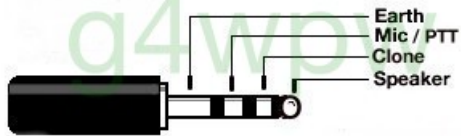

(see MH-34 / MH-34B4 / MH-57A4B ABOVE)

YAESU (Airband Tranceiver's) VXA-100 VXA-150 VXA-210

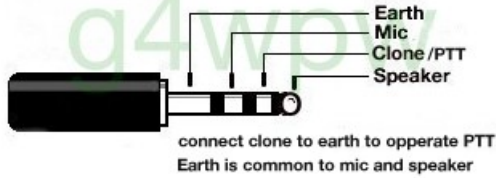

(see MH-44A4B ABOVE)

YAESU (Handheld Tranceiver's) FT-10R FT-40R FT-50R FT-60R

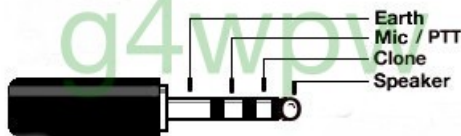

(see MH-37A4B ABOVE)

YAESU FT-50R FT-60R

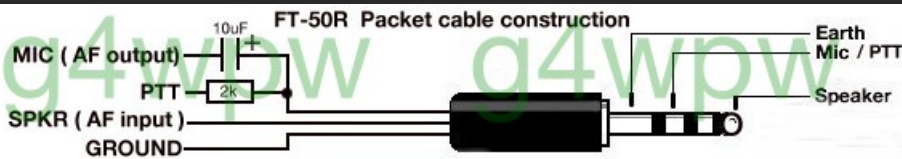

YAESU (Handheld Tranceiver's) FT-51R (see MH-32A2B / MH-34C2)

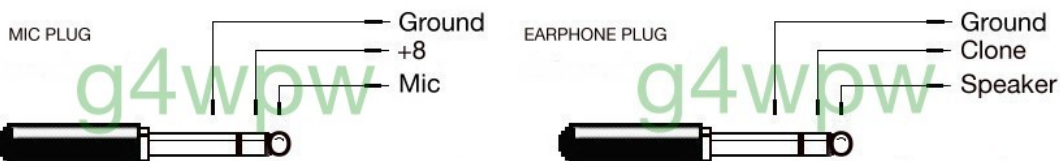

YAESU (Handheld Tranceiver's) FT-51RII

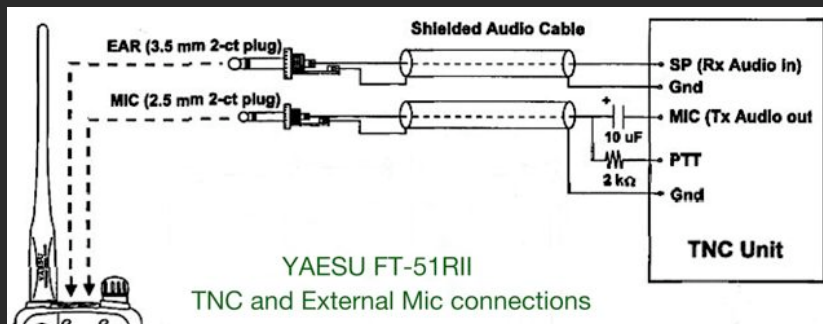

YAESU (Handheld Tranceiver's) FT-470 FT-411 FT-811 FT-911 (see MH-32A2B / MH-34C2)

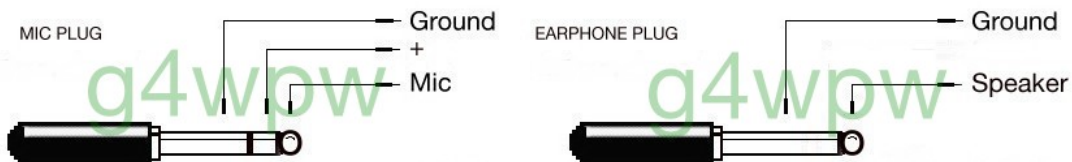

YAESU (Handheld Tranceiver's) FT-23 FT-73 FT-23R11 FT-73R11 (see MH-32A2B / MH-34C2)

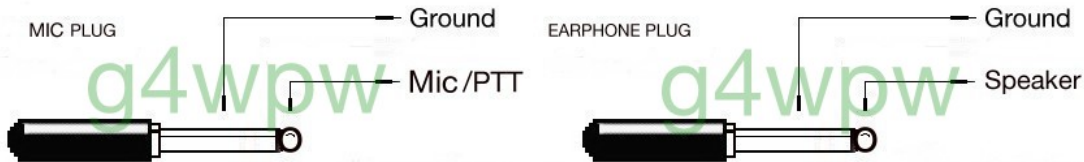

[CLONE INFO. pdf](#)

YAESU (Handheld Tranceiver's) FT-530 (see MH-12A2B / MH-18A2B)

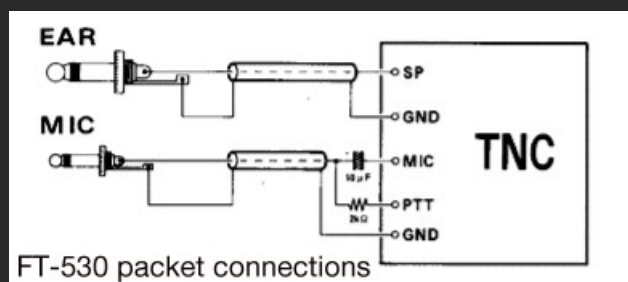
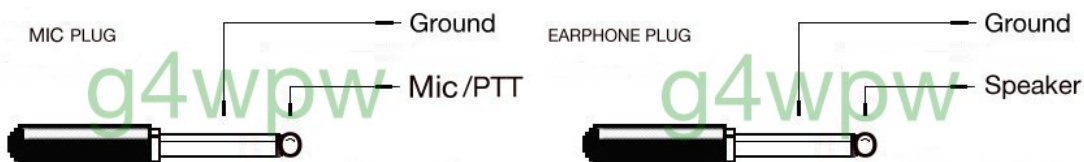

YAESU POLICE AND PUBLIC SAFETY CHANNELISED TRANCEIVERS

VX-2000 VX-2500 VX-3000 VX-3200 VX-4100 VX-4100E VX-4200 VX-4200E VXR-1000 VXR-7000

(See MH-25A8J / MD-11A8J microphones above)

PIN1	FAST
PIN2	GROUND
PIN3	PTT
PIN4	MIC
PIN5	MIC EARTH
PIN6	+ 5VOLTS
PIN7	UP
PIN8	DOWN

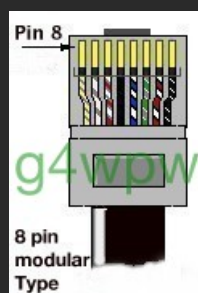

**YAESU-FT736-FT747GX-FT757GX-FT650-FT655-FT840-FT890-FT920-FT990-FT990D-FT847
FT1000-FT1000D-FT1000MP + MKV -FT2000**

PIN1	MIC UP
PIN2	EARTH (+ 5VOLTS FT847-FT920-FT1000MP-FT2000)
PIN3	DOWN
PIN4	FAST SCAN
PIN5	EARTH
PIN6	PTT
PIN7	SCREEN/EARTH
PIN8	MIC

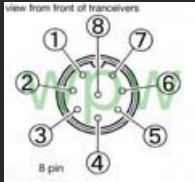

YAESUFTONE-FT77-FT102-FT707-FT767-FT767GX-FT980

PIN1	MIC UP
PIN2	+ 5 VOLTS
PIN3	DOWN
PIN4	FAST SCAN
PIN5	CAUTION INTERCONNECTED TO PIN 2.(+5 VOLTS)
PIN6	PTT
PIN7	SCREEN/EARTH
PIN8	MIC

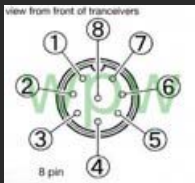

YAESU FT480R-FT780R (see YM-40 above)

PIN1 green	MIC UP
PIN2 yellow	EARTH / COMMON U/DOWN.
PIN3 blue	DOWN
PIN4 brown	TONE CALL / LOCK
PIN5 orange	EARTH TONE CALL / LOCK
PIN6 red	PTT
PIN7 black	SCREEN/EARTH
PIN8 white	MIC

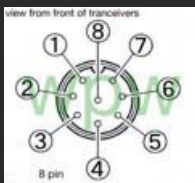

YAESU-FT726 (see MD1-B8 MH1-B8 Microphone above)

PIN1	UP
PIN2	COMMON UP/DOWN
PIN3	DOWN
PIN4	FAST SCAN
PIN5	EARTH
PIN6	PTT
PIN7	SCREEN/EARTH
PIN8	MIC

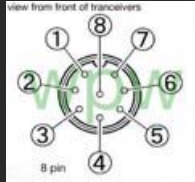

YAESU CPU2500R-CPU2500RK SOMMERKAMP FT227
 (see YM-2500 Microphone above)

PIN1	UP
PIN2	COMMON UP/DOWN
PIN3	DOWN
PIN4	PTT
PIN5	GROUND MIC/PTT
PIN6	MIC

[click for schematic](#)

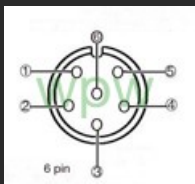

YAESU FT-620B
 (see YM-86 Microphone above)

PIN1	N/C
PIN2	N/C
PIN3	SCREEN
PIN4	PTT GROUND
PIN5	PTT
PIN6	MIC

[click for schematic](#)

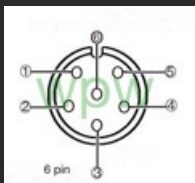

YAESU FT75-FT221R-FT223-FT101B-FT101E-FT101Z-FT101ZD-FT301D-FT902-FT902DM. (see YD148/YD844 microphone above.)

PIN1	MIC SCREEN/EARTH (PTT EARTH ON FT101B/101E.FT101Z/101ZD.FT902/902DM.)
PIN2	MIC
PIN3	PTT
PIN4	EARTH ON FT221R.(N/C ON FT101Z/101ZD.FT101B/101E.FT902/902DM.)



YAESU FTDX-100 FTDX-400 FTDX-401 FTDX-560 FT-200 FT-250(See YD-148 microphone above.)

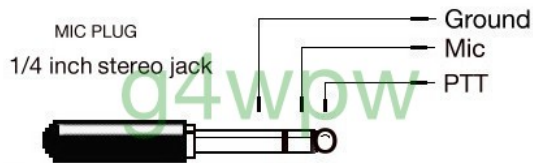

YAESU FT201-FT125C-FTC212-FT2B-FT300C-FT224-FT225RD-FT2FB-FT223-FT220-FTC212-FT300C FT301.
FT7-FT227R-FT227RA-FT227RX-FT250-FT401B-FT501-FT625-FL101.

(See YD-148 and YM-22 microphones above.)

YAESU-FT950

PIN1	MIC UP
PIN2	+ 5 VOLTS
PIN3	DOWN
PIN4	FAST SCAN
PIN5	GROUND
PIN6	PTT
PIN7	SCREEN/EARTH
PIN8	MIC

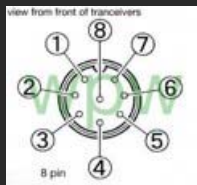

YAESU FT840-FT990.

PIN1	UP
PIN2	GROUND
PIN3	DOWN
PIN4	FAST
PIN5	GROUND (INTERCONNECTED ON TRANCEIVER TO PIN 2.)
PIN6	PTT
PIN7	MIC GROUND/SCREEN
PIN8	MIC

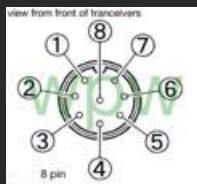

YAESU FT2200.

PIN1	UP
PIN2	+ 5 VOLTS
PIN3	DOWN
PIN4	SPEAKER .
PIN5	ACC .
PIN6	PTT
PIN7	MIC GROUND/SCREEN
PIN8	MIC

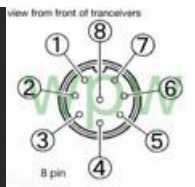

YAESU FT2500M.
8 Pin Modular plug.(see MH-26G8J MH-27G8J)

PIN1	CALL BUTTON.
PIN2	RX AUDIO.
PIN3	PTT.
PIN4	MIC.
PIN5	GROUND.
PIN6	+ 5 VOLTS
PIN7	UP.
PIN8	DOWN.

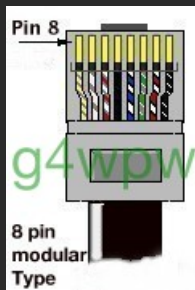

YAESU FT2400H.

PIN1	CALL BUTTON.
PIN2	RX AUDIO.
PIN3	PTT.
PIN4	MIC.
PIN5	GROUND.
PIN6	+ 5 VOLTS
PIN7	UP.
PIN8	DOWN.

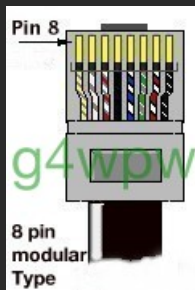

YAESU-FT-2600(6 Pin modular Plug)(See MH-42 and MH-36 microphone above)

PIN1	SW2
PIN2	CLONE
PIN3	+ 9VOLT
PIN4	GROUND
PIN5	MIC
PIN6	MULTI SWITCHING SW1

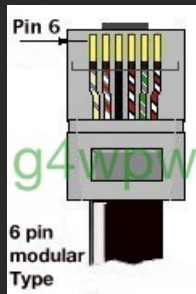

YAESU FT5100.

PIN1	UP.
PIN2	+ 5 VOLTS.
PIN3	DOWN.
PIN4	SPEAKER.
PIN5	BAND.
PIN6	PTT.
PIN7	EARTH.
PIN8	MIC.

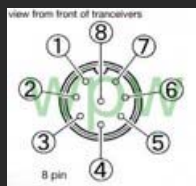

YAESU FT211-FT212R FT212RH-FT270-FT211RH-FT711-FT712-FT770-FT2311-FT2700-FT4700RH-FT711RH-FT770RH (see microphones MH-15D8/ MH-15C8/ MH-14A8/ MH-14B8/ MH-14D8 above)

PIN1	UP
PIN2	+5 VOLT
PIN3	DOWN
PIN4	SPEAKER
PIN5	CPU/ TONE SW
PIN6	PTT
PIN7	GROUND
PIN8	MIC



YAESU FT230R-FT290R-FT690 FT730-FT790R

PIN1	MIC SCREEN/EARTH
PIN2	MIC
PIN3	PTT
PIN4	+ 12VOLT (+ 5 VOLTS FT730-FT290R)
PIN5	SPEAKER
PIN6	UP
PIN7	DOWN

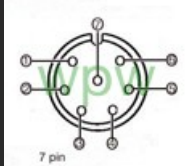

YAESU FT290RII-FT690RII-FT790RII (see MH-10E8 /MH-10F8 above)

PIN1	UP
PIN2	+ 5 VOLTS
PIN3	DOWN
PIN4	SPEAKER
PIN5	N/C
PIN6	PTT
PIN7	GROUND
PIN8	MIC

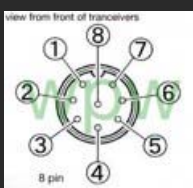

YAESU FT215-FT715-FT3700-FT3800-FT3900-FT4600-FT4800-FT4900-FT5800

PIN1	UP
PIN2	+ 5 VOLTS
PIN3	DOWN
PIN4	N/C
PIN5	RECALL
PIN6	RESET
PIN7	GROUND
PIN8	MIC

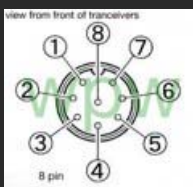

YAESU FT708R-FT208R HAND HELD. (mini) 6 PIN

PIN1	MIC (white)
PIN2	SPEAKER (black)
PIN3	PTT (red)
PIN4	MIC SCREEN
PIN5	NC
PIN6	SPEAKER (blue)

YAESU-FT897-FT857-FT817-FT900-FT-450 (8 pin Modular Plug)

PIN1	FAST SCAN
PIN2	GROUND
PIN3	PTT
PIN4	MIC
PIN5	MIC GROUND

PIN6 + 5VOLT
 PIN7 UP
 PIN8 DOWN

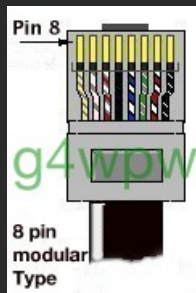

YAESU-FT1500-FT1802E-FT2800-FT7800M-FT8800E-FT8900R (6 Pin modular Plug) (See MH-48 microphone above)

PIN1 SW2
 PIN2 SW1
 PIN3 + 8VOLT
 PIN4 GROUND
 PIN5 MIC
 PIN6 PTT (clone FT1802E)

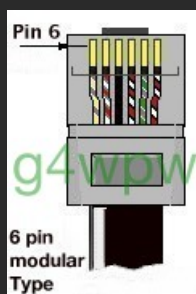

YAESU-FTM-10R/E (WITH BUILT IN MICROPHONE AND BLUE TOOTH.)

NEEDS MEK-M10 ADAPTER TO USE THE FOLLOWING EXTERNAL MICROPHONES

MH-68 A6J WATERPROOF MIC

MH-68 B6J WATERPROOF MIC

MEK-M10 ADAPTER CONNECTIONS.pdf

YAESU-FTDX9000D (3 pin XLR Plug front panel) PLUS (8 pin Plug rear panel.)

(XLR PLUG FRONT PANEL.)

PIN1 MIC GRND.
 PIN2 MIC HOT.
 PIN3 MIC COLD.

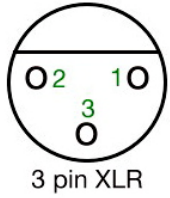

(8 PIN PLUG REAR PANEL.)

PIN1	UP.
PIN2	+5 VOLTS.
PIN3	DOWN.
PIN4	FAST SCAN.
PIN5	GROUND.
PIN6	PTT.
PIN7	MIC GROUND.
PIN8	MIC.

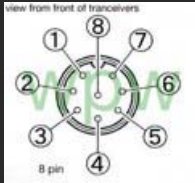

YAESU-FT100-FT90-FT8100 (6 pin Modular Plug) (SEE MH-36 microphone above.)

PIN1	Multi-function switching for P,P1,P2 SW2.
PIN2	N.C. 9600bps packet data out FT-90
PIN3	+ 9VOLT
PIN4	EARTH
PIN5	MIC.
PIN6	SW1. PTT,UP,DOWN,Acc

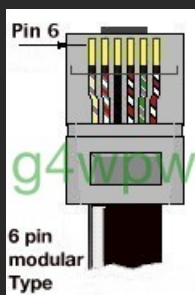

Connector Pinouts

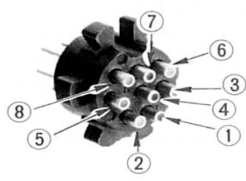
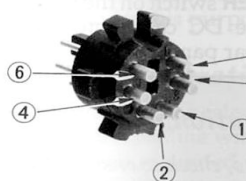
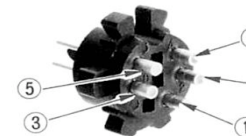
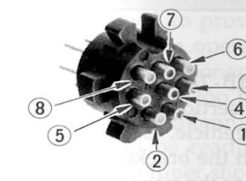
BAND DATA	CAT
 <p>1. +13.5 V 2. TX GND 3. GND 4. BAND DATA A 5. BAND DATA B 6. BAND DATA C 7. BAND DATA D 8. LINEAR</p>	 <p>1. GND 2. SERIAL OUT 3. SERIAL IN 4. PTT 5. S/PO 6. NC</p>
TUNER 1 (used w / FC-800)	TUNER 2 (used w / FC-10)
 <p>1. GND 2.+13.5V 3. DATA 4. GND 5. GND BY FC-800</p>	 <p>1. +13.5V 2. TX GND 3. GND 4. DATA IN 5. DATA OUT 6. TUNER SENSE 7. RESET 8. TX INH</p>

Yaesu "cat" pinout connections.

MORE YAESU INFORMATION

[\(click for\) -YAESU FT-100 SERIES CONNECTION DIAGRAMS.](#)
[\(click for\) -YAESU FT-600 SERIES CONNECTION DIAGRAMS.](#)
[\(click for\) -YAESU FT-707 SERIES CONNECTION DIAGRAMS.](#)
[\(click for\) -YAESU FT-726 SERIES CONNECTION DIAGRAMS.](#)
[\(click for\) -YAESU FT-736 SERIES CONNECTION DIAGRAMS.](#)
[\(click for\) -YAESU FT-747 SERIES CONNECTION DIAGRAMS.](#)
[\(click for\) -YAESU FT-757 SERIES CONNECTION DIAGRAMS.](#)
[\(click for\) -YAESU FT-767 SERIES CONNECTION DIAGRAMS.](#)
[\(click for\) -YAESU FT-817 SERIES CONNECTION DIAGRAMS.](#)
[\(click for\) -YAESU FT-847 SERIES CONNECTION DIAGRAMS.](#)
[\(click for\) -YAESU FT-897 SERIES CONNECTION DIAGRAMS.](#)
[\(click for\) -YAESU FT-920 SERIES CONNECTION DIAGRAMS.](#)
[\(click for\) -YAESU FT-980 SERIES CONNECTION DIAGRAMS.](#)
[\(click for\) -YAESU FT-990 SERIES CONNECTION DIAGRAMS.](#)
[\(click for\) -YAESU FTM-10 SERIES CONNECTION DIAGRAMS.pdf](#)
[\(click for\) -YAESU FT-1000MP SERIES CONNECTION DIAGRAMS.](#)
[\(click for\) -YAESU FT-2000 SERIES CONNECTION DIAGRAMS.pdf](#)
[\(click for\) -YAESU FT-7100 SERIES CONNECTION DIAGRAMS.](#)
[\(click for\) -YAESU FT-8900 SERIES CONNECTION DIAGRAMS.pdf](#)
[\(click for\) -YAESU FTDX-9000D SERIES CONNECTION DIAGRAMS.](#)

ICOM.

ICOM-IC7400-IC746-IC746PRO-IC756PRO-IC7700-IC7800 (see HM-36 below)

PIN1	MIC + DC VOLTS FOR ICOM ONLY MICROPHONE
PIN2	+ 8VOLTS 10Ma <u>TO AVOID DAMAGING THE REGULATOR DO NOT SHORT TO GROUND</u>
PIN3	UP/DOWN
PIN4	SQUELCH
PIN5	PTT
PIN6	GROUND
PIN7	MIC SCREEN/EARTH
PIN8	AUDIO OUT



ICOM-IC703-IC706MK1-IC706MK2-IC706MK3-IC2000-IC2000H (8 Pin Modular Plug)

PIN1	+ 8VOLT
PIN2	UP/DOWN
PIN3	AUDIO OUT
PIN4	PTT
PIN5	MIC GROUND
PIN6	MIC
PIN7	GROUND/EARTH
PIN8	SQUELCH

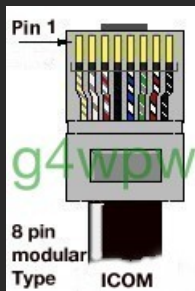

ICOM-ICE-208-IC2100H-IC2200H-IC2725E-IC2820-(See HM-133 below) (8 Pin Modular Plug)

PIN1	+ 8VOLT OUTPUT (10 ma max)
PIN2	UP/DOWN
PIN3	+ 8VOLTS IN (No connection IC2100H)
PIN4	PTT
PIN5	MIC GROUND
PIN6	MIC
PIN7	GROUND/EARTH
PIN8	DATA IN (No connection IC2100H)

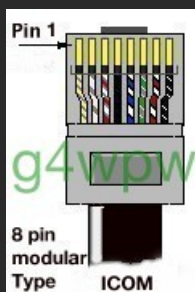

ICOM-IC-7000 (8 Pin Modular Plug)

IMPORTANT! SEE HM-151 MICROPHONE INFO BELOW.

PIN1	+ 8VOLT OUTPUT (10 ma max)
PIN2	UP/DOWN
PIN3	+ 8VOLTS SW
PIN4	PTT
PIN5	MIC GROUND
PIN6	MIC
PIN7	GROUND/EARTH
PIN8	DATA IN

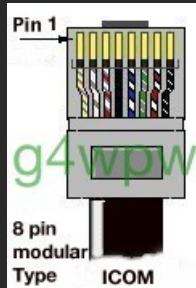

ICOM-IC-2800 (8 Pin Modular Plug) SEE HM-98 MICROPHONE BELOW.

PIN1	+ 8VOLT OUTPUT (10 ma max)
PIN2	UP/DOWN
PIN3	+ 8VOLTS SW
PIN4	PTT
PIN5	MIC GROUND
PIN6	MIC
PIN7	GROUND/EARTH
PIN8	DATA IN

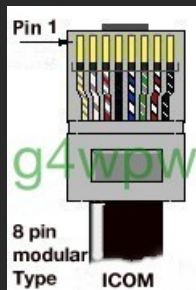

ICOM-IC-2800 (8 Pin Modular Plug) SEE HM-98 MICROPHONE BELOW.

PIN1	+ 8VOLT OUTPUT (10 ma max)
PIN2	UP/DOWN
PIN3	+ 8VOLTS SW
PIN4	PTT
PIN5	MIC GROUND
PIN6	MIC
PIN7	GROUND/EARTH
PIN8	DATA IN

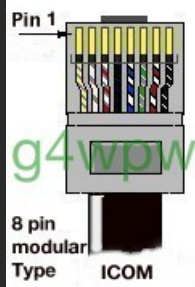

ICOM LAND MOBILE(8 Pin Modular Plug) SEE SM-25 SM-100/T MICROPHONES BELOW.
F320-F420-F1020-F2020-F121-F221-F521-F620-F621/TR-F1721D-F182D-F272D
F282D-FR3000-FR4000-FR5000-FR5100-FR6100.

PIN1	+ 8 VOLTS
PIN2	UP /DOWN.
PIN3	AF OUTPUT.
PIN4	PTT.
PIN5	MIC GROUND.
PIN6	MIC AUDIO.
PIN7	GROUND /EARTH.
PIN8	SQUELCH (SOME MODELS)

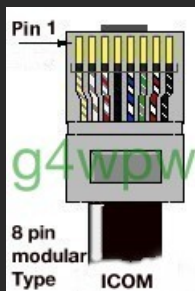

ICOM HAND HELD- ICE90- IC91A/E- ICE7- ICT2A/E/H-ICT3H ICT7A/E/H- ICT21A/E -ICT22 -ICT41E- ICT81A/E-
ICV8- ICV21AT- ICV82
ICV82- ICT90- ICF3

(SEE HM-46 HM75A HM-131 BELOW)

ICOM HAND HELD- IC4A/AT/E-IC3A/AT-IC12A/AT/E-IC80AD

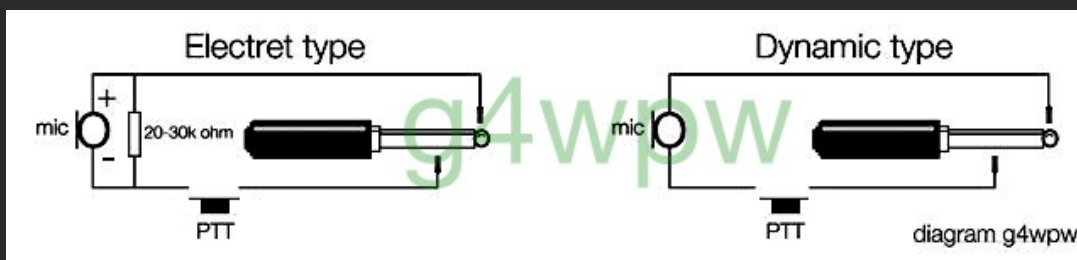

ICOM HAND HELD- ICT8A- ICT8E

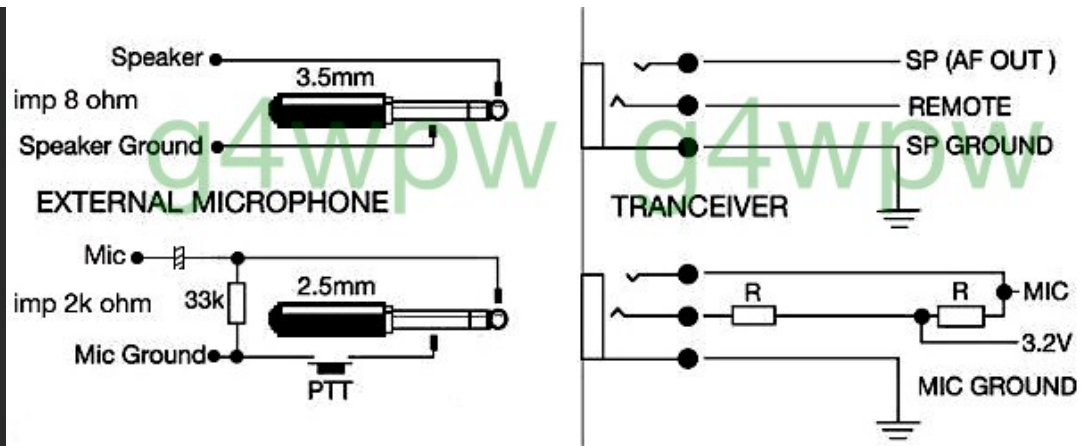

ICOM-IC-211 IC-701

PIN1	MIC
PIN2	PTT
PIN3	N/C
PIN4	GROUND.



ICOM IC-120-271A-271E-275-290-228-229-229H-22U-25-25E-27-27E-28-29E-255-260-290-2400-2500-3200-3210-3220
 IC-37A-38A-375-45-47-77-78-451-471A-475-48-490-505-551-560-575-707-718-720-725-726-728-729-730-735-736-737/A-738
 IC-740-745-746-751/A-756/PRO-761-765-775-781-820H-821-821H-900-901-901H-910X-970-1200-1201-1271-1275

PIN1	MIC (yellow)
PIN2	REPEATER TONE (+ 8/9 volts some models)
PIN3	UP/DOWN
PIN4	N/C (squelch some models)
PIN5	PTT (red)
PIN6	EARTH (black)
PIN7	MIC SCREEN
PIN8	N/C (green) (external speaker some models)

(For IC-27 / 27E see IC-HM24 below) (IC-22U see IC-HM8 below)



ICOM-IC24G-IC251E-IC451E. (See SM-5 plus IC-HM7 hand mic & SM-5 desc mic.)

PIN1	MIC (white. <u>connection at + 9VOLTS above earth</u>)
PIN2	NC
PIN3	NC
PIN4	NC
PIN5	PTT (red)
PIN6	PTT (black)
PIN7	MIC SCREEN
PIN8	NC

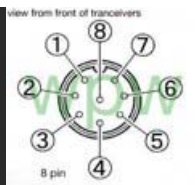

ICOM MICROPHONES.

ICOM- SM2 MIC CONNECTIONS.

ICOM- SM5 MIC CONNECTIONS.

ICOM- SM6 MIC CONNECTIONS.

ICOM- SM8 MIC CONNECTIONS.

ICOM- SM10 MIC CONNECTIONS.

ICOM- SM20 MIC CONNECTIONS.

MORE- SM20 MIC INFORMATION.

ICOM- SM25 MIC CONNECTIONS.

ICOM- IC-HM5 MIC CONNECTIONS.

ICOM- IC-HM7 HAND MIC CONNECTIONS.

ICOM- IC-HM8 HAND MIC CONNECTIONS.

ICOM- IC-HM10 MIC CONNECTIONS.

ICOM- IC-HM11 MIC CONNECTIONS.

ICOM- IC-HM12 MIC CONNECTIONS.

ICOM- HM12 MIC CONNECTIONS.

MORE- IC-HM12 MIC INFORMATION.

ICOM- IC-HM14 MIC CONNECTIONS.

ICOM- IC-HM15 MIC CONNECTIONS.

ICOM- HM-22 MIC CONNECTIONS.

ICOM- HM-23 MIC CONNECTIONS.

ICOM- HM-24 MIC CONNECTIONS.

ICOM- HM-36 MIC CONNECTIONS.

ICOM- HM-46 MIC CONNECTIONS.

ICOM- HM-54 MIC CONNECTIONS.

ICOM- HM-56/56A MIC CONNECTIONS.

ICOM- HM-75A MIC CONNECTIONS.

ICOM- HM77-HM78-HM79-HM95-HM97 MIC CONNECTIONS.

ICOM- HM-90 WIRELESS MIC CONNECTIONS.

ICOM- HM-95 MIC CONNECTIONS.

ICOM- HM-96 MIC CONNECTIONS.

ICOM- HM-97 MIC CONNECTIONS.

ICOM- HM-98S MIC CONNECTIONS.

ICOM- HM-100 HM-100T MIC CONNECTIONS.

ICOM- HM-103 MIC CONNECTIONS.

ICOM- HM-113-113V MIC CONNECTIONS.

ICOM- HM-128L MIC CONNECTIONS.

ICOM- HM-118-118TN MIC CONNECTIONS.

ICOM- HM-131 MIC CONNECTIONS.

ICOM-HM-148/G MIC CONNECTIONS.

ICOM- HM-133 MIC CONNECTIONS.

ICOM- HM-151 MIC CONNECTIONS (IC-7000).

ICOM- HM-152 MIC CONNECTIONS.

ICOM- HM-153L MIC CONNECTIONS.

ICOM- HM-154 / HM-154T MIC CONNECTIONS.

CONVERTING THE ICOM- HM-154 / HM-154T MIC FROM RJ-45 TO 8 PIN CONNECTIONS.

ICOM- HM-158L MIC CONNECTIONS.

ICOM- HM-166L MIC CONNECTIONS.

IC-821H- ACC SOCKET CONNECTIONS.

click for MORE ICOM INFORMATION.

click for ICOM MICROPHONE COMPATIBILITY LIST 2009

click for ICOM CONNECTING CABLE REFERENCE LIST.

click to download FREE ICOM MANUALS.

CAUTION !

IF YOU WISH TO USE THE FOLLOWING ICOM MICROPHONE'S (model's below) ON

TRANCEIVERS OTHER THAN ICOM, CHECK THIS [link](#) INFORMATION ALSO

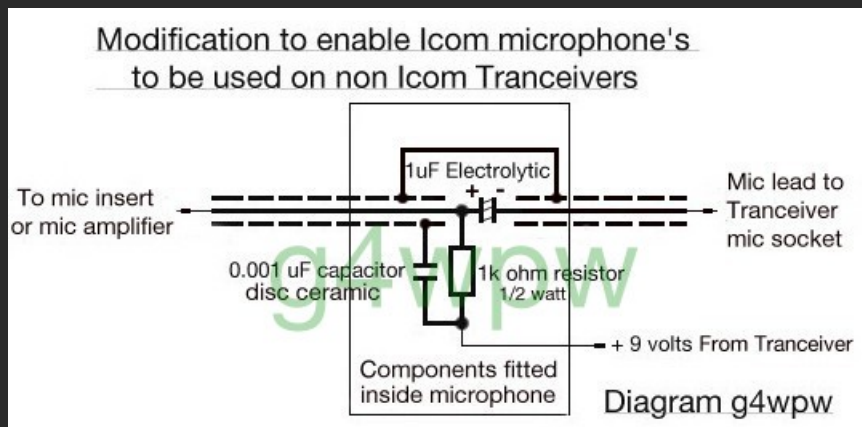
**MICROPHONE MODEL'S**

IC-SM8 IC-SM6 IC-HM7 IC-HM11 IC-HM12 IC-HM14 IC-HM15 IC-HM22 IC-HM24 IC-HM36

ALINCO.

[Click here to Download ALINCO Instruction/Service manuals FREE.](#)

PIN 1 MIC (yellow)
PIN 2 PTT (orange)
PIN 3 DWN (white)
PIN 4 UP (green)
PIN 5 +5v (red) max current 25mA
PIN 6 (purple) see notes:
PIN 7 MIC GND (black/shield)
PIN 8 GND (grey)

note:

PIN 6 info:

DR-590/592/599/600=bus line for remote commands from mic

DR-110/112/570=no connection

DR-130=pc programming bus

view from cable side of plug

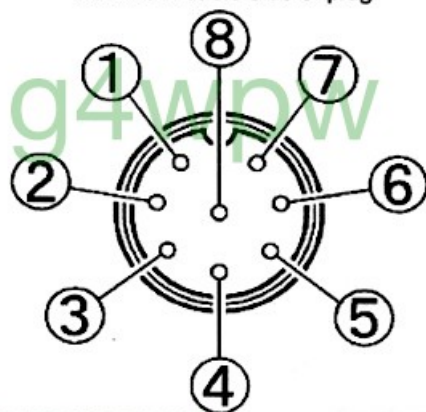

ALINCO MOBILE RADIO'S

ALINCO DX70-DX70T-DX77-DX701-DX707-DR110-DR112-DR119-DR135-DR-330 DR435-DR150E-DR150TE-DR235-
DR-410-DR430-DR435-DR510-DR570
-DR590-DR592T-DR599T-DR600T-DR610-DR620-DR635-DR1200-DRM03-DRM06-ALR22H-ALD24T-ALR22T-ALR72T-

PIN1	MIC
PIN2	PTT
PIN3	DOWN
PIN4	UP
PIN5	+ 5VOLT (Max current 25Ma) (+ 8VOLT ALR-22/24)
PIN6	AUDIO OUT (remote DR150TE-DR590-DR592-DR599-DR600) SEE ABOVE DIAGRAM REFERENCE.
PIN7	MIC SCREEN/EARTH
PIN8	EARTH

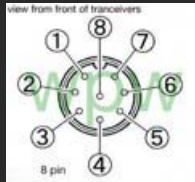

ALINCO DR140-DR605 (Modular Plug)

PIN1	UP.
PIN2	GROUND.
PIN3	MIC.
PIN4	MIC GROUND.
PIN5	PTT.
PIN6	N/C.
PIN7	DOWN.
PIN8	+ 5 VOLTS.

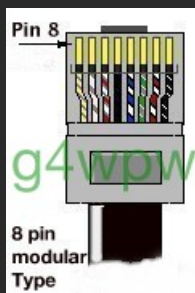

ALINCO 22T/E.24E/T

PIN1	MIC
PIN2	PTT
PIN3	DOWN
PIN4	UP
PIN5	+ 8VOLT
PIN6	N/C
PIN7	MIC EARTH
PIN8	GROUND

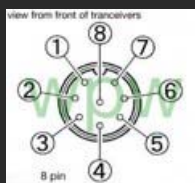

ALINCO EMS-14. - ADONIS AM-508E. - WATSON AM308 MICROPHONE COLOR CODING.

YELLOW	MIC
SCREEN	EARTH (ground)
GREY	PTT (+ VOLTAGE FEED ON ADONIS D80)
BLUE	PTT EARTH ON WATSON 308.
PURPLE	PTT EARTH (ground)
GREEN	MIC UP
ORANGE	COMMON (connect to ground)
WHITE	MIC DOWN (+ VOLTS WATSON AM-308)
BLACK	MIC DOWN ON WATSON AM-308

RED + VOLTS FEED(PTT ON ADONIS D80 AND WATSON AM-308)

ALINCO DMR610 DR-135 DR-435.

- PIN 1 MIC
- PIN 2 PTT
- PIN 3 DOWN
- PIN 4 UP
- PIN 5 +5 VOLTS
- PIN 6 REMOTE CONTROL
- PIN 7 SCREEN EARTH (ground)
- PIN 8 GND

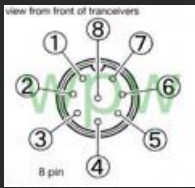

ALINCO. DJ-S11 DJ-41 DJ-180 DJ-190 DJ-191 DJ-491G DJ-G1 DJ-G5

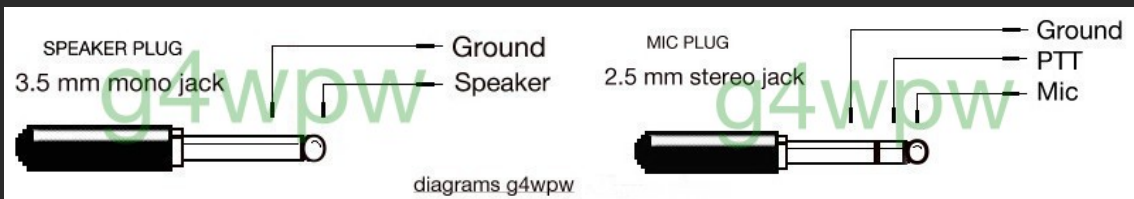

ALINCO. DJ-560 DJ-580

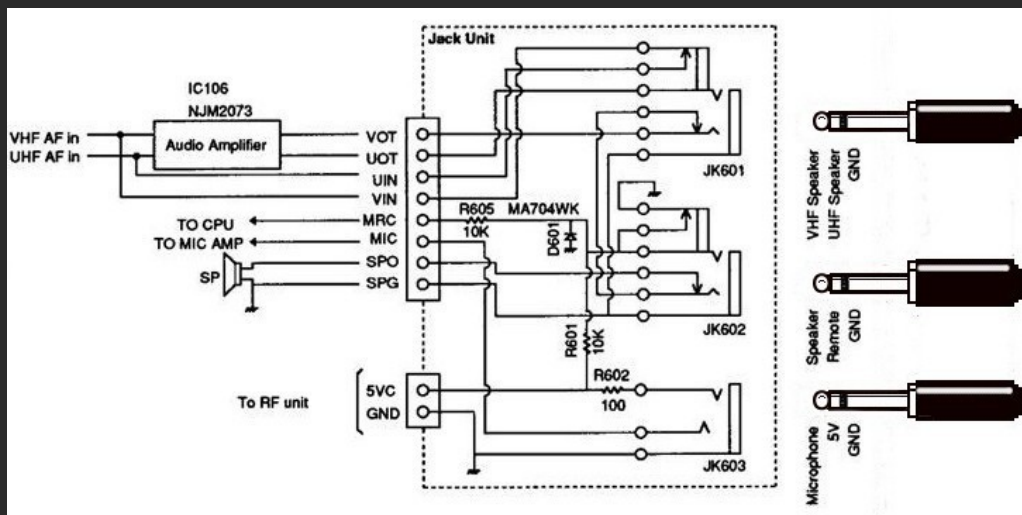

ALINCO HANDHELD. DJ-V17 DJ-V17E DJ-V17T DJ-V17TFH DJ-47E DJ-47T DJ-47T1 DJ-47T2

[click for schematic](#)

ALINCO MICROPHONES

[EMS-5A.MIC CONNECTIONS.](#)
[EMS-14.MIC CONNECTIONS.](#)
[EMS-42.MIC CONNECTIONS.](#)
[EMS-45.MIC CONNECTIONS.](#)
[EMS-46.MIC CONNECTIONS.](#)
[EMS-47.MIC CONNECTIONS.](#)
[EMS-51.MIC CONNECTIONS.](#)
[EMS-52.MIC CONNECTIONS.](#)
[EMS-53.MIC CONNECTIONS.](#)
[EMS-52 / 53.MIC SCHEMATICS.](#)
[EMS-54.MIC CONNECTIONS.](#)
[EMS-55.MIC CONNECTIONS.](#)
[EMS-54 / 55.MIC SCHEMATICS.](#)
[EMS-56.MIC CONNECTIONS.](#)
[EMS-56.MIC SCHEMATIC.](#)
[EMS-57.MIC CONNECTIONS.](#)
[EMS-57.MIC SCHEMATIC.](#)

ADONIS.

[ADONIS- AM-DX1 MICROPHONE INSTRUCTIONS AND SCHEMATIC.pdf](#)
[ADONIS- AM-308 MICROPHONE INSTRUCTIONS AND SCHEMATIC.pdf](#)
[ADONIS- AM-503G MICROPHONE INSTRUCTIONS AND SCHEMATIC.pdf](#)
[ADONIS- AM-508e MICROPHONE INSTRUCTIONS AND SCHEMATIC.pdf](#)
[ADONIS- AM-708 MICROPHONE INSTRUCTIONS AND SCHEMATIC.pdf](#)
[ADONIS- AM-7500e MICROPHONE INSTRUCTIONS AND SCHEMATIC.pdf](#)
[ADONIS- AM-308 / AM-508 / AM-608 / AM-708 / AM-7500E MICROPHONE PHOTO'S](#)
[ADONIS- FX-6 MICROPHONE INSTRUCTIONS AND SCHEMATIC.pdf](#)
[ADONIS- WX-2400 MICROPHONE INSTRUCTIONS AND SCHEMATIC.pdf](#)
[ADONIS- BOOM1 MICROPHONE CONNECTIONS.pdf](#)

ADONIS MICROPHONE INTERCONNECTING CABLE INFO.

INFO TO CONNECT ADONIS AM-DX1 AM-308 AM-508 AM-708 AM-7500e TO YAESU FT-847 FT-920 FT-1000MP.

ADONIS MICROPHONE CONVERSION LEADS FOR AM-708 ABOVE.

ADONIS LEAD NUMBER D-88K AS-327 (Connections for Kenwood configuration)

SILVER PLUG END (tranceiver).		ORANGE PLUG END (connected to microphone).	
PIN 1	YELLOW. connected to	PIN 2.	YELLOW.(mic)
PIN 2	RED. ..	PIN 3.	RED.(ptt)
PIN 3	WHITE. ..	PIN 6.	WHITE.(down)
PIN 4	GREEN. ..	PIN 5.	GREEN.(up)
PIN 5	GREY. ..	PIN 8.	GREY.(+volts DC feed)
PIN 6	N/C. ..	PIN 4.	PURPLE.(ptt ground)
PIN 7	SCREEN. ..	PIN 1.	SCREEN.(mic ground)
PIN 8	ORANGE+PURPLE. ..	PIN 7.	ORANGE.(up/down common ground)

ADONIS LEAD NUMBER D-80K AS-340

This is sold as a spare lead with only orange (mic end) plug fitted.

ORANGE PLUG END (connected to microphone).

PIN 2.YELLOW.(mic)
 PIN 3.RED.(ptt)
 PIN 6.WHITE.(down)
 PIN 5.GREEN.(up)
 PIN 8.GREY.(+volts DC feed)
 PIN 4.PURPLE.(ptt ground)
 PIN 1.SCREEN.(mic ground)
 PIN 7.ORANGE.(up/down common ground)

COLOURS AND CONNECTIONS ON THE ORANGE (mic) PLUG ENDS OF LEADS ARE IDENTICAL.

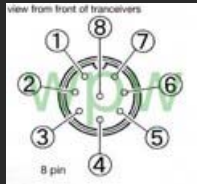

STANDARD ADONIS MICROPHONE COLOR CODING

YELLOW. (mic)

RED. (ptt)

WHITE. (down)

GREEN. (up)

GREY. (+volts DC feed)

PURPLE. (ptt ground)

SCREEN. (mic ground)

ORANGE. (up/down common ground)

ADI.

ADI AR-146 AR-147 AR-247 AR-446 AR-447

8 PIN ROUND PLUG.

PIN 1	MIC.
PIN 2	PTT.
PIN 3	DOWN.
PIN 4	UP.
PIN 5	+ 8VOLTS (max 150 Ma).
PIN 6	RX AUDIO OUT.
PIN 7	MIC SCREEN.
PIN 8	GROUND.

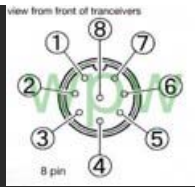

AEA.

AEA. DX-HANDY 6M,DX-HANDY 10M

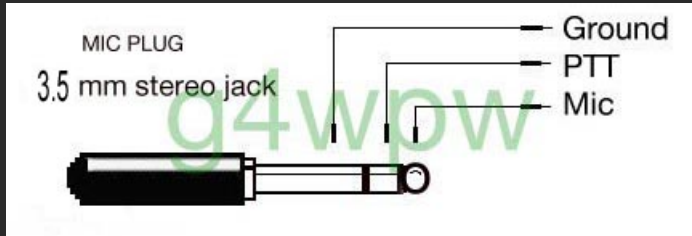

ALBRECT.

AE485 MIC SCHEMATIC.

AE497 MIC SCHEMATIC.

AE560 MIC SCHEMATIC.

AKD/GAREX.

AKD/GAREX. 2001-4001-6001-7003

4 PIN PLUG.

PIN 1	MIC.
PIN 2	COMMON EARTH.
PIN 3	AUDIO OUTPUT.
PIN 4	PTT.



ASTATIC.

ASTATIC 531 schematic.

ASTATIC D104 schematic.

ASTATIC MICROPHONE WIRING REFERENCE pdf**ATLAS.**

ATLAS TRANCEIVERS MODELS.-TX110-180-210-215-350XL.
ATLAS-VX5 VOX UNIT.

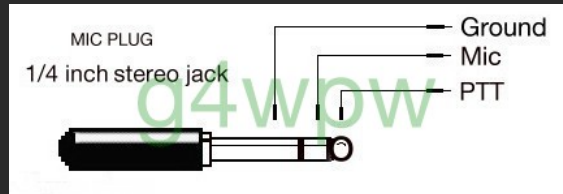
**AZDEN.**

PCS-5000-6000-7000-7200-7300-7600-7800-9600

PIN 1	MIC.
PIN 2	MIC GROUND.
PIN 3	tone BURST (connect to pin 6)
PIN 4	DOWN.
PIN 5	UP.
PIN 6	COMMON GROUND.
PIN 7	PTT.
PIN 8	+13.8 VOLTS

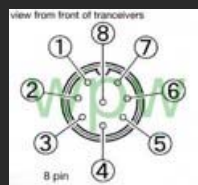

AZDEN-PCM-463 MICROPHONE INFO.

CES MICROPHONES.

CES-600L MICROPHONE.pdf

CES-805 MICROPHONE.pdf

COLLINS.

KMW-1 KWM-2 KWM-2A KWM-380 KWM-390, 312B-4, 312B-5, (S-LINE) 32S-1.

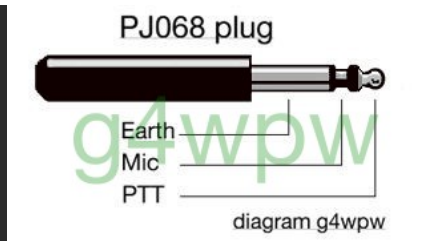

COLLINS SM1/SM3 MICROPHONE INFO.

COLLINS 32V KW-1 KWS-1

PIN 1 MIC AUDIO.

PIN 2 PTT.

CASE COMMON GROUND/EARTH

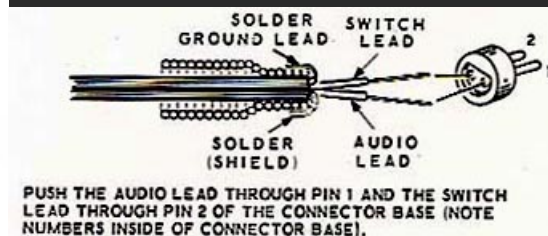

COLLINS 32RA.

PIN 1 COMMON GROUND/EARTH.

PIN 2 PTT.

PIN 3 MIC AUDIO.



DRAKE.

DRAKE. TR-5 TR-7 TR-7A

4 PIN PLUG.

PIN 1	MIC.
PIN 2	PTT.
PIN 3/4	EARTH/GROUND.



DRAKE. TR-22

3 PIN LOCKING RING TYPE PLUG.

PIN 1	MIC.
PIN 2	PTT.
PIN 3	EARTH.



DRAKE. TR-72

4 PIN PLUG.

PIN 1	MIC.
PIN 2	PTT.
PIN 3/4	EARTH/GROUND.



DRAKE. TR-270

4 PIN PLUG.

PIN 1	MIC.
PIN 2	PTT.
PIN 3	COMMON EARTH.
PIN 4	+ 10 VOLTS



DRAKE. TR-3 T4 TR-4 TR-4B TR-4XB TR-4XC TR-4C T-4XC T-4XB TR-6

(S230 Mic Plug.)

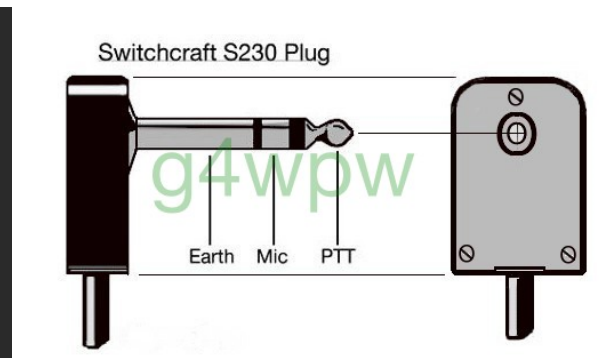

ELECRAFT.

K3

PIN 1	MIC.
PIN 2	PTT.
PIN 3	DOWN
PIN 4	UP.
PIN 5	FUNCTION.
PIN 6	8 VOLTS.
PIN 7	GROUND.
PIN 8	GROUND.

FDK.

FDK. MULTI-11 MULTI-UII MULTI-II MULTI-700E MULTI-700EX MULTI-800 MULTI-2000 MULTI-2700

4 PIN ROUND PLUG.

PIN 1/4	GROUND / MIC SREEN
PIN 2	PTT.
PIN 3	MIC.



FDK. MULTI-750A MULTI-750E MULTI-725

6 PIN ROUND PLUG.

PIN 1	MIC
PIN 2	PTT.
PIN 3	UP.
PIN 4	+ 5V
PIN 5	GROUND.
PIN 6	DOWN.

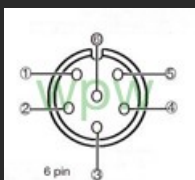

HALLICRAFTER.

HT-46

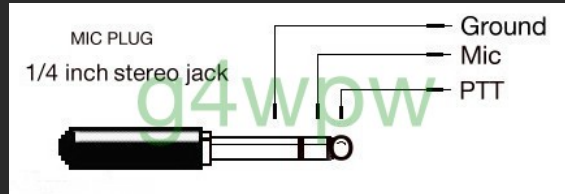

HALLICRAFTER. HT-32 HT-36 HT-44 SR-42 SR-42A SR-46 SR-150 SR-160 SR-400 SR-400A SR-500 SR-540 SR-2000

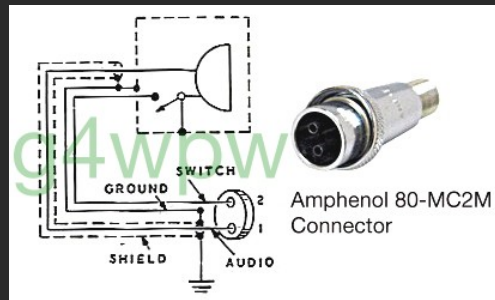

HALLICRAFTER. HT-40 HT-37



HEATHKIT.

Heathkit- SB-100 / SB-104 mic Connection

Heathkit- HW-12 / HW-22 mic Connection

Heathkit- HW-17 mic Connection

HEIL.

HM-10 DUAL, GM-4,GM-5,GMV. HANDIMIC-HM-4, HM-5, HM-iC, HM-PRO. CLASSIC.
4 PIN XLR PLUG.

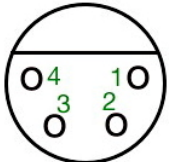

4 pin XLR

PIN 1 GROUND/SHIELD.
 PIN 2 MIC.
 PIN 3/4 PTT.

**PRO-20, PRO-30, PRO-40, CLASSIC PRO, HERITAGE.
 3 PIN XLR PLUG.**

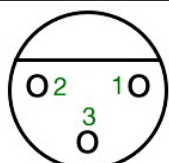

3 pin XLR

UNBALANCED OUTPUT.

PIN 1 SHIELD.
 PIN 2 + MIC.
 PIN 3 - MIC. (connected to pin 1)

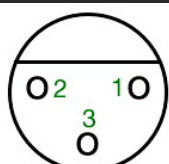

3 pin XLR

BALANCED OUTPUT.

PIN 1 SHIELD.
 PIN 2 + MIC OUTPUT
 PIN 3 - MIC GROUND

HEIL TRAVELER HEADSET

PIN 1 MIC.
 PIN 2 +8 VOLTS.
 PIN 3 U/DOWN.
 PIN 4 SQUELCH.
 PIN 5 PTT.
 PIN 6 EARTH PTT.
 PIN 7 MIC EARTH.
 PIN 8 AUDIO OUTPUT.

THE HEIL CONNECTION SYSTEM.

MORE INFORMATION FROM THE HEIL WEBSITE.

JCD-201M DESK MIC.

PIN1 (E) BRAID.
 PIN2 (M) (MIC) BROWN
 PIN3 (P) (GROUND) WHITE
 PIN4 (G) (PTT) GREEN
 PIN5 (U) (UP) BLACK
 PIN6 (D) (DOWN) YELLOW
 PIN7 (C) (UP/DOWN EARTH) BLUE
 PIN8 (B) (+5 - +9VOLTS DC) RED

JCD-201M PHOTO.

JRC.

JST-100 JST-100D JST-100S JST-110 JST-135 JST-145 JST-245.

PIN1	MIC UP
PIN2	NC
PIN3	MIC DOWN
PIN4	+ 9 VOLTS
PIN5	PTT EARTH
PIN6	PTT
PIN7	MIC EARTH
PIN8	MIC

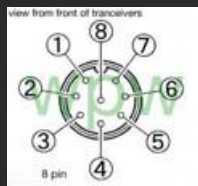

NVT-56 / 57 / 58 MICROPHONE INFO.

KACHINA.

KACHINA. 505DSP.

8 PIN ROUND PLUG.

PIN 1	GROUND.
PIN 2	MIC.
PIN 3	PTT.
PIN 4	SPEAKER.
PIN 5	N/C.
PIN 6	N/C.
PIN 7	N/C.
PIN 8	N/C.

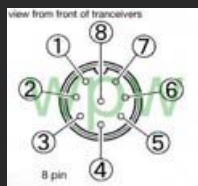

(info AE5K)

KDK.

KDK. FM-2016 FM-2025**4 PIN ROUND PLUG.**

PIN 1	PTT GROUND.
PIN 2	PTT.
PIN 3	MIC SCREEN.
PIN 4	MIC.

**KDK. FM-2030 FM-2033****6 PIN ROUND PLUG.**

PIN 1	UP/DOWN GROUND.
PIN 2	UP.
PIN 3	DOWN.
PIN 4	PTT.
PIN 5	MIC.
PIN 6	MIC SREEN/GROUND.

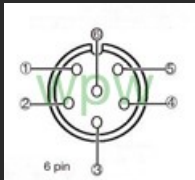
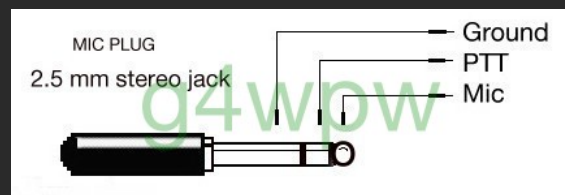
**KDK DM-TT1 MICROPHONE****KDK TM-2 MICROPHONE****KDK DM-100 MICROPHONE****KW.****KW TRANSMITTERS /TRANCEIVERS KW-1 KW-2000 KW-2000A KW-2000B KW-VESPA KW-VICEROY****MFJ.****MFJ-8621. DATA CONNECTIONS. Must be configured for 1200 baud operation.**

Note:This radio has un-squelched output.use "software DCD"

PIN1	AFSK In (yellow)
PIN2	GROUND/EARTH (black)
PIN3	PTT (red)
PIN4	AFSK Out (green)

MFJ-297 MFJ-299 MICROPHONES.

PIN1	MIC GROUND
PIN2	MIC
PIN3	PTT
PIN4	PTT GROUND
PIN5	UP
PIN6	DOWN
PIN7	COMMON UP/DOWN
PIN8	DC VOLTS.

MFJ-299 INSTRUCTION MANUAL WITH (ICOM, YAESU, KENWOOD, CONNECTION INFO.)

MFJ-434 VOICE KEYS INFO.pdf

DOWNLOAD MFJ PRODUCT MANUALS FREE.

MOTOROLA.

CM140-160-200-300-340-360 EM200-400 GM300-3188-3688.
M10-120-130-208-216-1255-1255LS-MaxTrac PM400-SM120-SM50.

PIN1	N/C
PIN2	N/C
PIN3	GROUND (blue)
PIN4	GROUND (black)
PIN5	MIC (red)
PIN6	PTT (green)
PIN7	N/C (yellow)
PIN8	AUDIO (blue)

HMN-1035 MIC SCHEMATIC.pdf

NAVICO.

AMR-1000/S.

PIN1	MIC GROUND 0VOLTS
PIN2	PHONES
PIN3	CRADLE
PIN4	PTT
PIN5	MIC
PIN6	+12 VOLTS
PIN7	DOWN
PIN8	UP

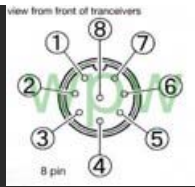

NEC.

NEC. CQ110E

4 PIN ROUND PLUG.

PIN 1+4 (INTERCONNECTED) GROUND / MIC SCREEN
 PIN 2 PTT.
 PIN 3 MIC.



RADIO SHACK.

RADIO SHACK. (Modular Connector)

Models HTX-212.HTX242.

PIN2 GROUND/EARTH (black)
 green EXTERNAL SPEAKER
 PIN5 MIC (yellow)
 PIN6 PTT (red)

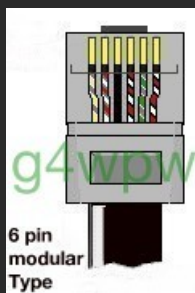

RADIO SHACK- HTX-100 MICROPHONE INFO.

RADIO SHACK- HTX-242 MICROPHONE SCHEMATIC.

RADIO SHACK- HTX-252 MICROPHONE INFO.(pdf)

SGC.

SG-2020.

PIN 1 MIC.

PIN 2	PTT.
PIN 3	OPT 1.
PIN 4	OPT 2.
PIN 5	N/C.
PIN 6	RX AUDIO OUT.
PIN 7	MIC GROUND.
PIN 8	GROUND.

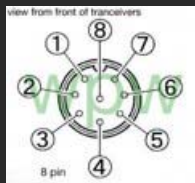

SOMMERKAMP

TS-280FM TS-480FM.

ACCESSORY JACK

The 8-pin DIN standard accessory jack has the following internal connections:

- | | |
|------------------------------------|-------------------------------|
| 1. Microphone input (Z600-10K ohm) | 6. +12V for VOX unit etc. |
| 2. Transmit/Receive switching | 7. AF out for selective call. |
| 3. Ground (SP) | 8. EXT. Squelch. |
| 4. Audio output. (Z8-10K ohm) | Case = ground |
| 5. Internal speaker. | |

Always operate the transceiver with the microphone plug inserted in the microphone jack, or with the following external connections:

1. Microphone with VOX.

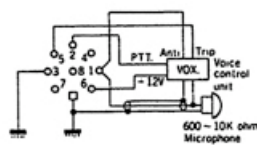

2. Headset or Telephoneset with PTT.

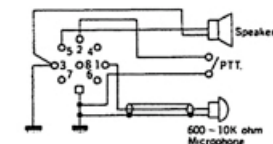

3. External microphone

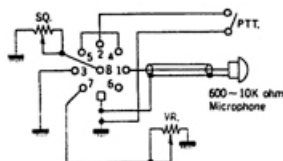

4. Headset or Telephoneset with VOX.

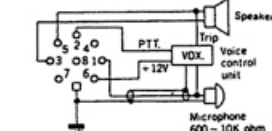

5. External microphone/Speaker with PTT.

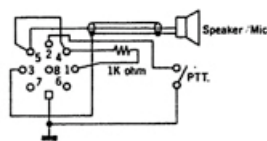

6. Internal connection

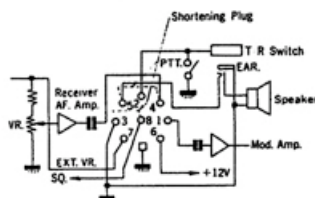

7. Internal connection with SP. selection switch

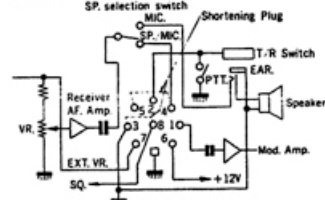

8. Parrot 76

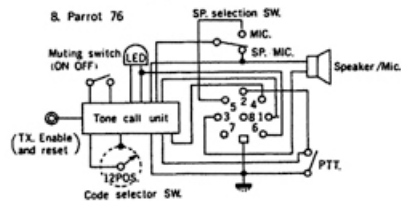

SOMERKAMP

FT-307CBM (see YAESU FT-107)

FT-277ZD (see YAESU FT-101ZD)

FT-767DX (see YAESU FT-707)

FT-7B (see YAESU FT-7)

STANDARD.

C58-C78-C88-C1100-C4100-C5800-C7800-C8800-C8900

PIN 1	MIC.
PIN 2	PTT.
PIN 3	SPEAKER.
PIN 4	COMMON (NOTE:+8VOLTS ON THIS CONNECTION.)
PIN 5	DOWN.
PIN 6	UP.
PIN 7	GROUND.

Note.0.001uF capacitor is connected between pin 1 and pin 7

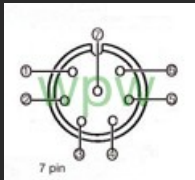

STANDARD.

C5000-C5200-C6000-C6000S

PIN 1	MIC.
PIN 2	PTT.
PIN 3	SPEAKER.
PIN 4	COMMON.
PIN 5	UP.
PIN 6	DOWN.
PIN 7	CALL.
PIN 8	GROUND.

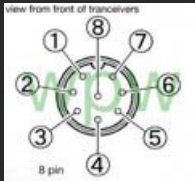

C5608

PIN 1	MIC.
PIN 2	PTT.
PIN 3	SPEAKER.
PIN 4	+ 7.5 VOLTS.
PIN 5,6,7	MICROPROCESSOR INTERFACE PINS.
PIN 8	GROUND.

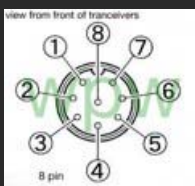

STANDARD.

C5900 (8 pin modular type plug.)

PIN 1
 PIN 2
 PIN 3
 PIN 4 PTT.
 PIN 5 GROUND.
 PIN 6 MIC.
 PIN 7
 PIN 8

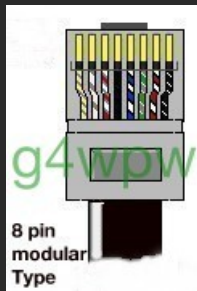

SWAN.

SWAN.100MX-120-100SS-140-175-200A-240-250C-350-400-500-500C-600T-700 SERIES-750.
ASTRO-102BX-103.CYGNET-270B-300B.

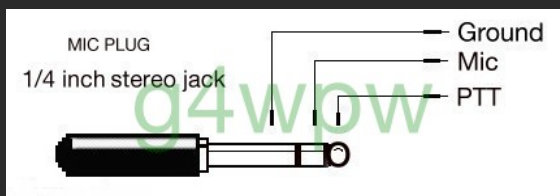

SHURE.

Shure- 444 schematic.

Shure- 522 schematic.

Shure- 527B schematic.

Shure- 550L schematic.

MORE SHURE MICROPHONE INFO.

TEN TEC.

ORION / ARGONAUT / JUPITER.info and Schematic.

TEN-TEC ORION - ARGONAUT - JUPITER - OMNI VI - PARAGON - DELTA II - CORSAIR - SCOUT-555
4 PIN PLUG.

PIN1 MIC +
 PIN2 MIC -
 PIN3 PTT
 PIN4 +9 VOLTS.
 SHELL/CHASSIS=GROUND



TEN-TEC ORION II / OMNI VII. 8 PIN PLUG.

PIN1	N/C
PIN2	+10 VOLTS
PIN3	N/C
PIN4	N/C
PIN5	GROUND
PIN6	PTT
PIN7	MIC EARTH
PIN8	MIC

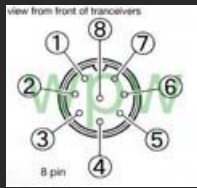

[OMNI-VII microphone info and Schematic.](#)

[ORION-II microphone info and Schematic.](#)

[TEN-TEC 705 MICROPHONE pdf](#)

TURNER.

[TURNER- EXPANDER 500.schematic.](#)

[TURNER- EXPANDER 500 AMPLIFIER .schematic.](#)

[TURNER- M+2U - JM+2U.schematic.](#)

[TURNER- +3 AMPLIFIER.schematic.pdf](#)

[TURNER- SUPER SIDEKICK and +3 schematic.](#)

[TURNER- ROAD KING 56.schematic.](#)

[TURNER- RK60 / RK60J / PLUS+2 / M+3.schematic.](#)

VIKING.(E.F.Johnson Co)

VIKING-II.



**VIKING RANGER -RANGER II -VALIANT -VALIANT II -VIKING 500 -INVADER 2000 -VIKING PACEMAKER
-INVADER .**



Amphenol Type
Connector (2 pin)

Pin 1 MIC.
Pin 2 PTT.
PLUG CASE EARTH.

**VIKING MESSENGER.
40-50-80-4170-4175
VIKING.230-260-270-430.**

Pin 1 MIC.
Pin 2 PTT/COMMON GROUND.
Pin 3 RECEIVE.
Pin 4 N/C.
Pin 5 PTT.
Pin 6 MIC SHIELD.

**VIKING MESSENGER.
124**

Pin 1 MIC.
Pin 2 PTT/COMON GROUND.
Pin 3 PTT.
Pin 4 N/C.

**VIKING MESSENGER.
130-130A-132**

Pin 1 MIC.
Pin 2 N/C.
Pin 3 PTT GROUND.
Pin 4 MIC GROUND.
Pin 5 SHIELD /MIC GROUND.

**VIKING MESSENGER.
250**

Pin 1 MIC.
Pin 2 PTT/COMON GROUND.
Pin 3 RECEIVE.
Pin 4 N/C.
Pin 5 PTT.
CASE SHIELD.

**VIKING MESSENGER.
4230**

Pin 1 PTT.
Pin 2 N/C.
Pin 3 PTT.

Pin 4 MIC.
 Pin 5 N/C.
 CASE SHIELD/COMMON GROUND.

**VIKING MESSENGER.
 4250**

Pin 1 N/C
 Pin 2 MIC.
 Pin 3 PTT.
 Pin 4 PPT/COMON GROUND.
 Pin 5 N/C.
 Pin 6 MIC SHIELD.

**VIKING MESSENGER.
 4730**

Pin 1 PTT.
 Pin 2 PTT.
 CASE SHIELD/COMMON GROUND.

**VIKING MESSENGER.
 4740
 VIKING 352-352D.**

PIN 1 MIC.
 PIN 2 PTT.
 PIN 3 N/C.
 PIN 4 N/C.
 PIN 5 PTT/GROUND.
 CASE SHIELD MIC GROUND.

VIKING MOBILE.

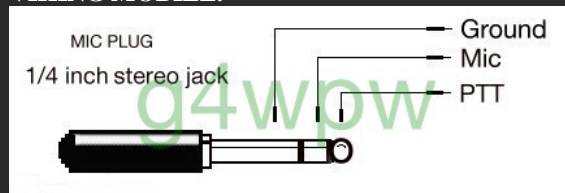

WATSON

Watson WM-308 (see Adonis AM-308 above)

AUDIO SECTION



IW5EDI CB MICROPHONE CONNECTIONS.

(The above information is consistently cross checked and updated)

last - update

08th-MAY-2010

©copyright g4wpw

G4WPW HOME PAGE.

Welcome! you are visitor No:

478132

Counting started 20-Apr-2007

ALL GENUINE GUESTBOOK ENTRIES ARE APPRECIATED.



rg4wpw@ntlworld.com

RETURN TO TOP

This web page is designed on MAC OS-X and checked on SAFARI, EXPLORER and FIREFOX browsers.

**Downloaded by
RadioAmateur.EU**